

1

37+22

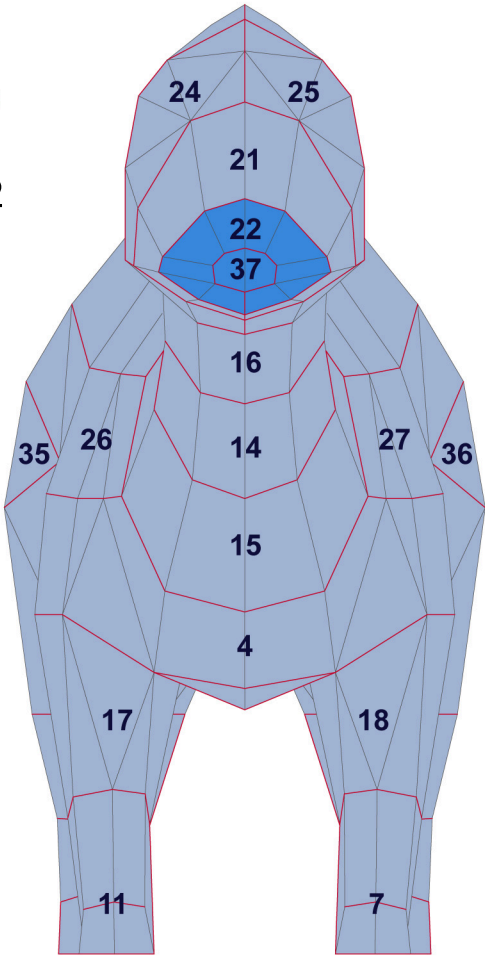

2

21

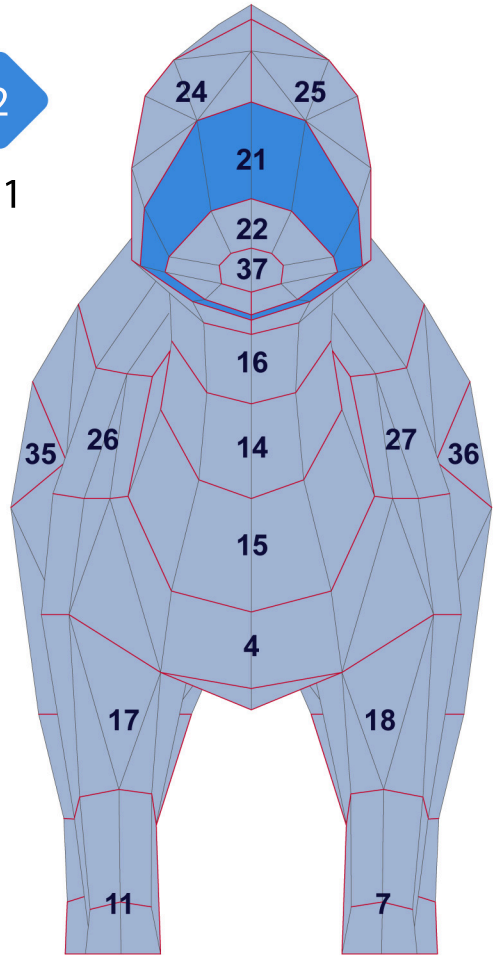

3

24+25

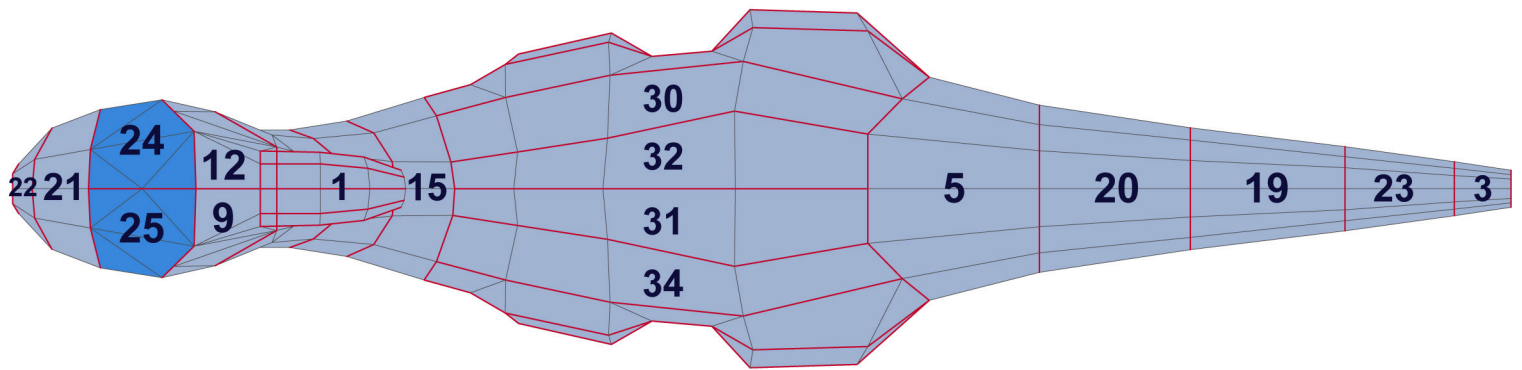

4

9

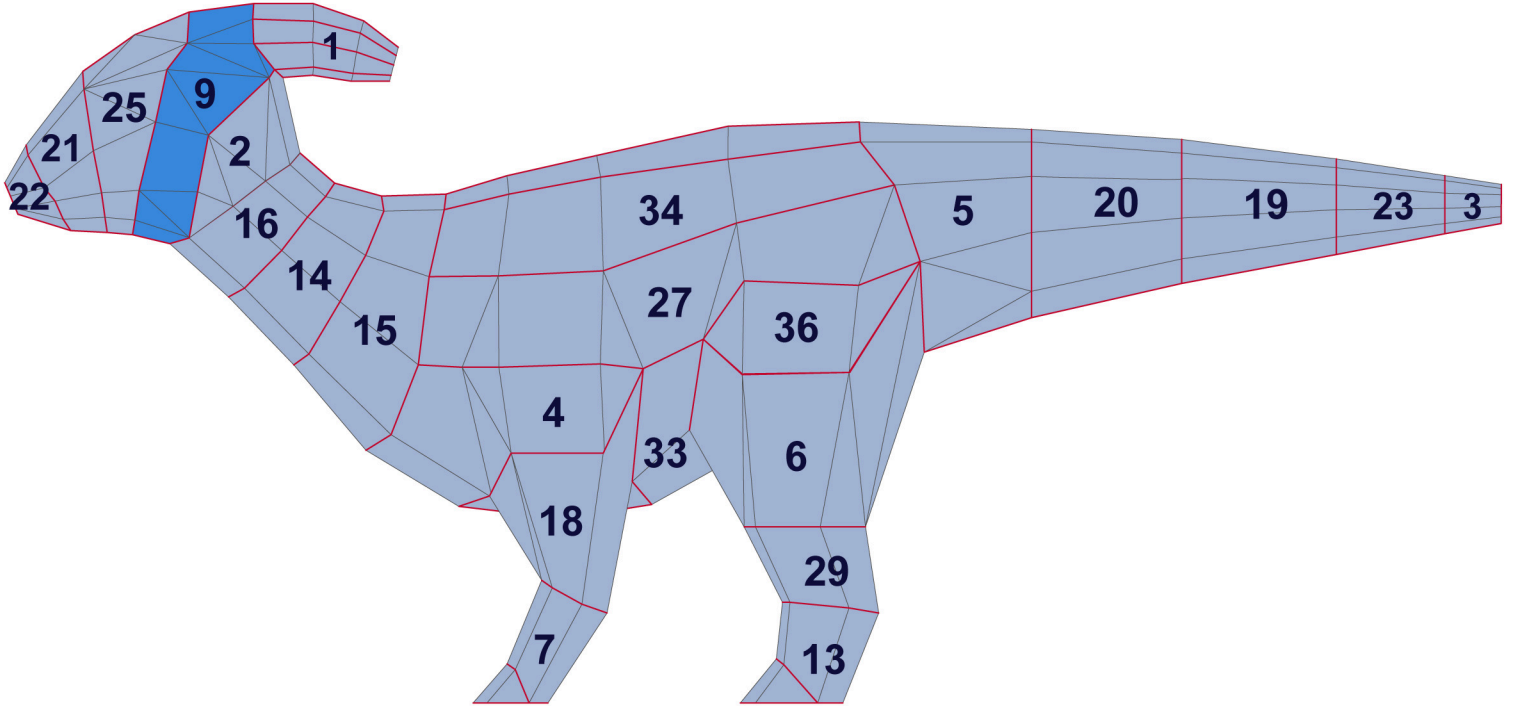

5

12

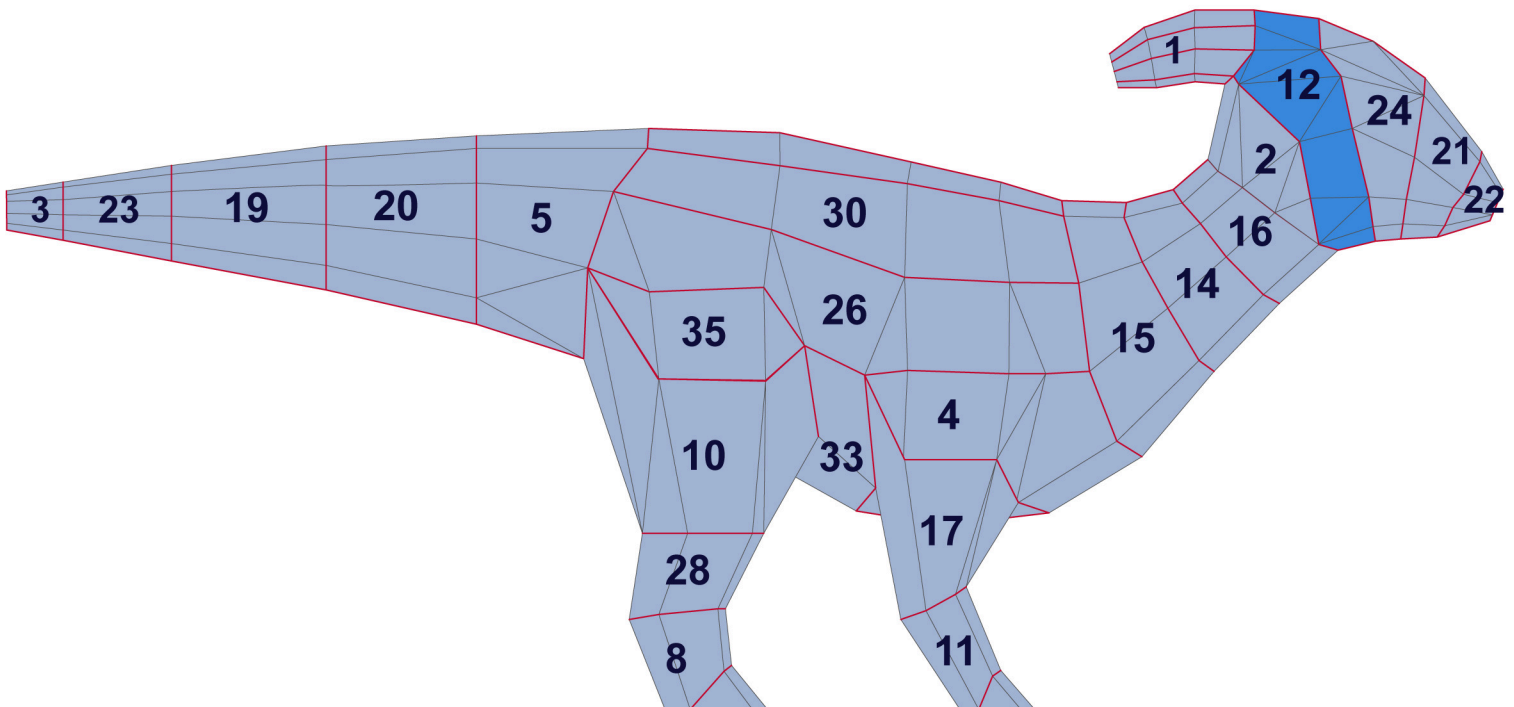

6

1

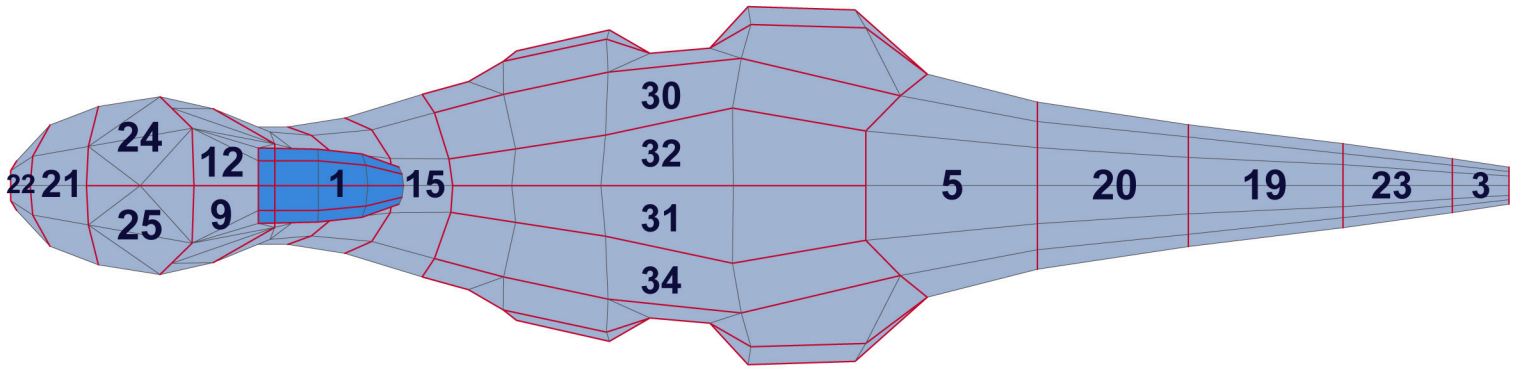

7

2

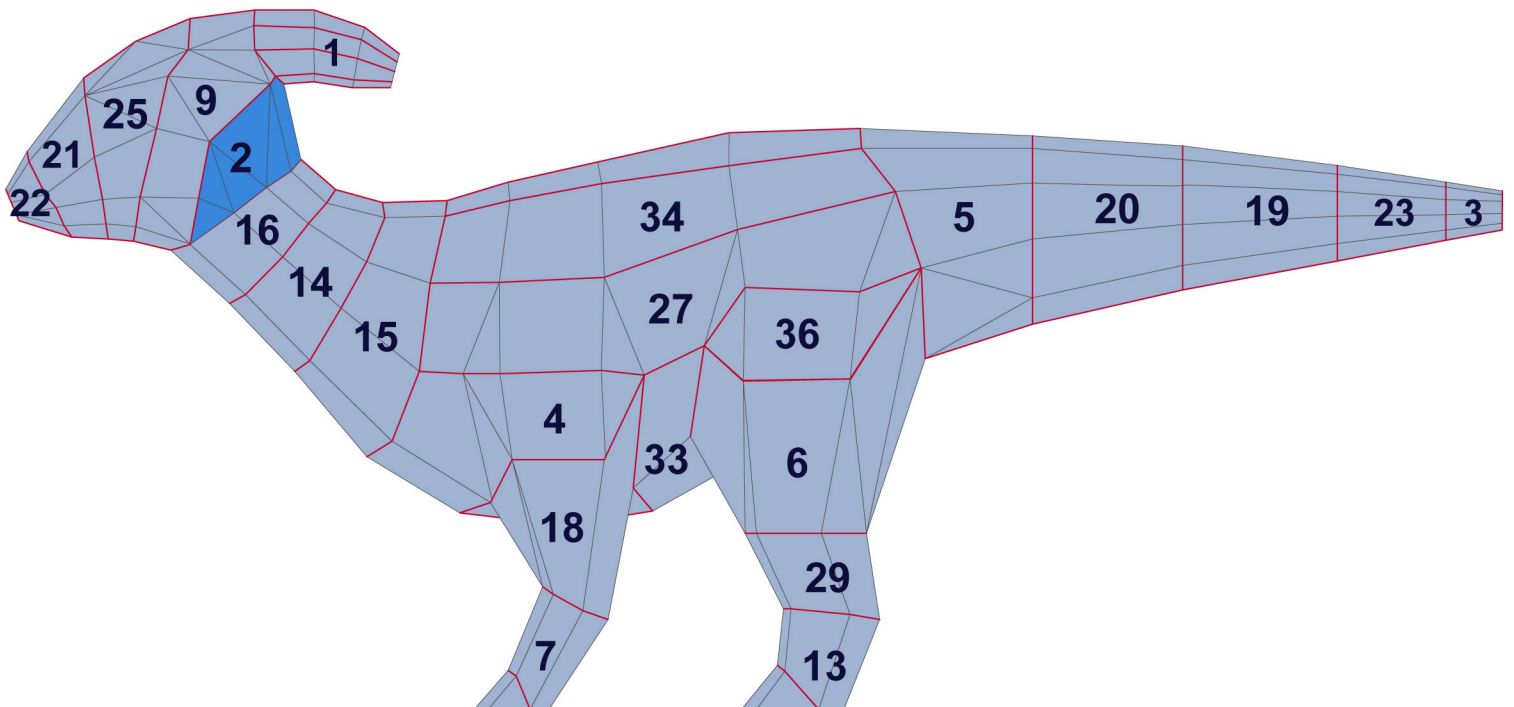

8

16

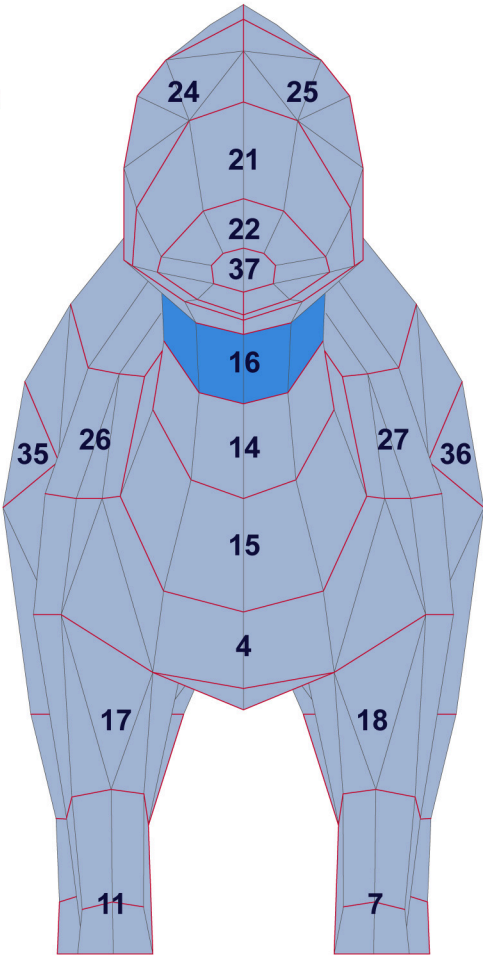

9

14

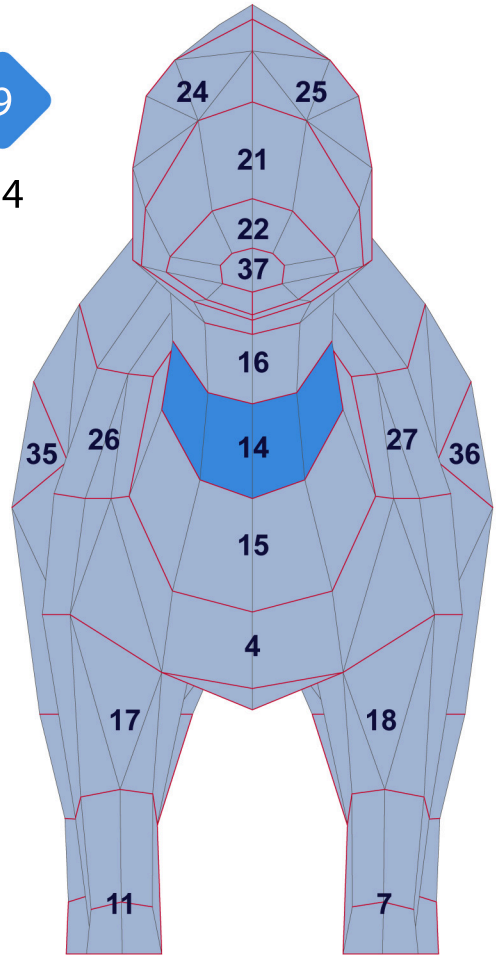

10

15

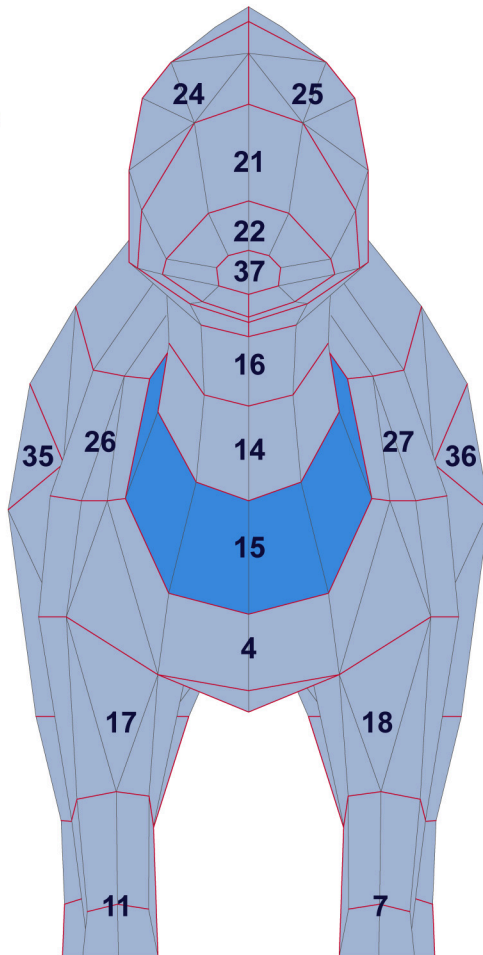

11

4

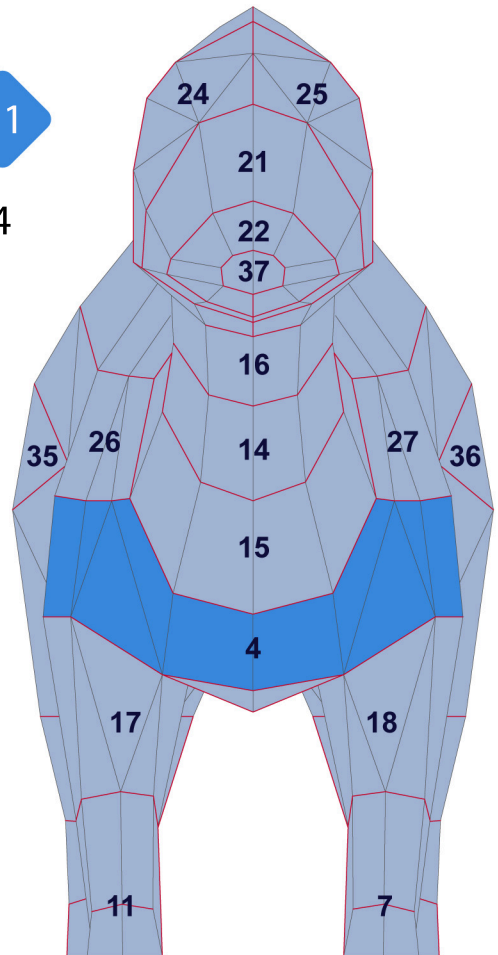

12

7+18

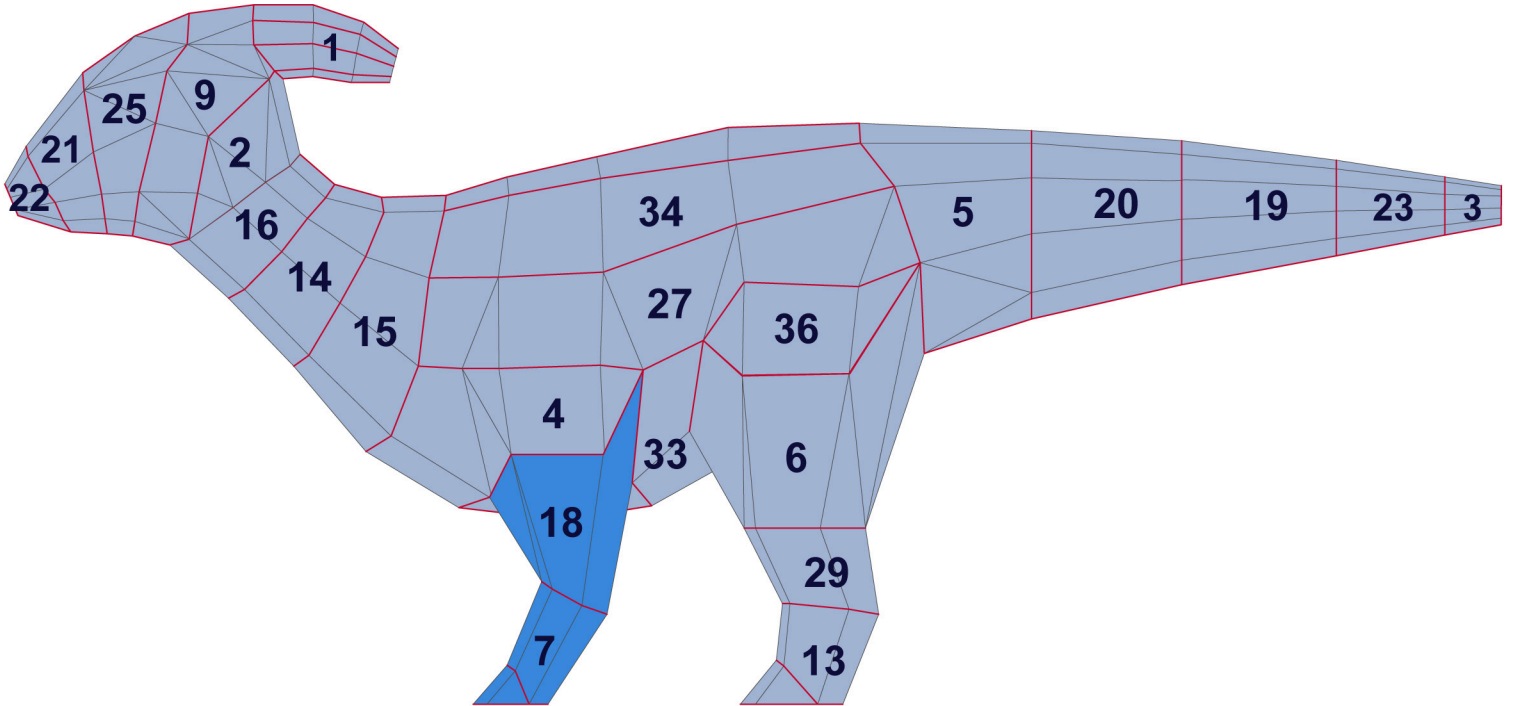

13

11+17

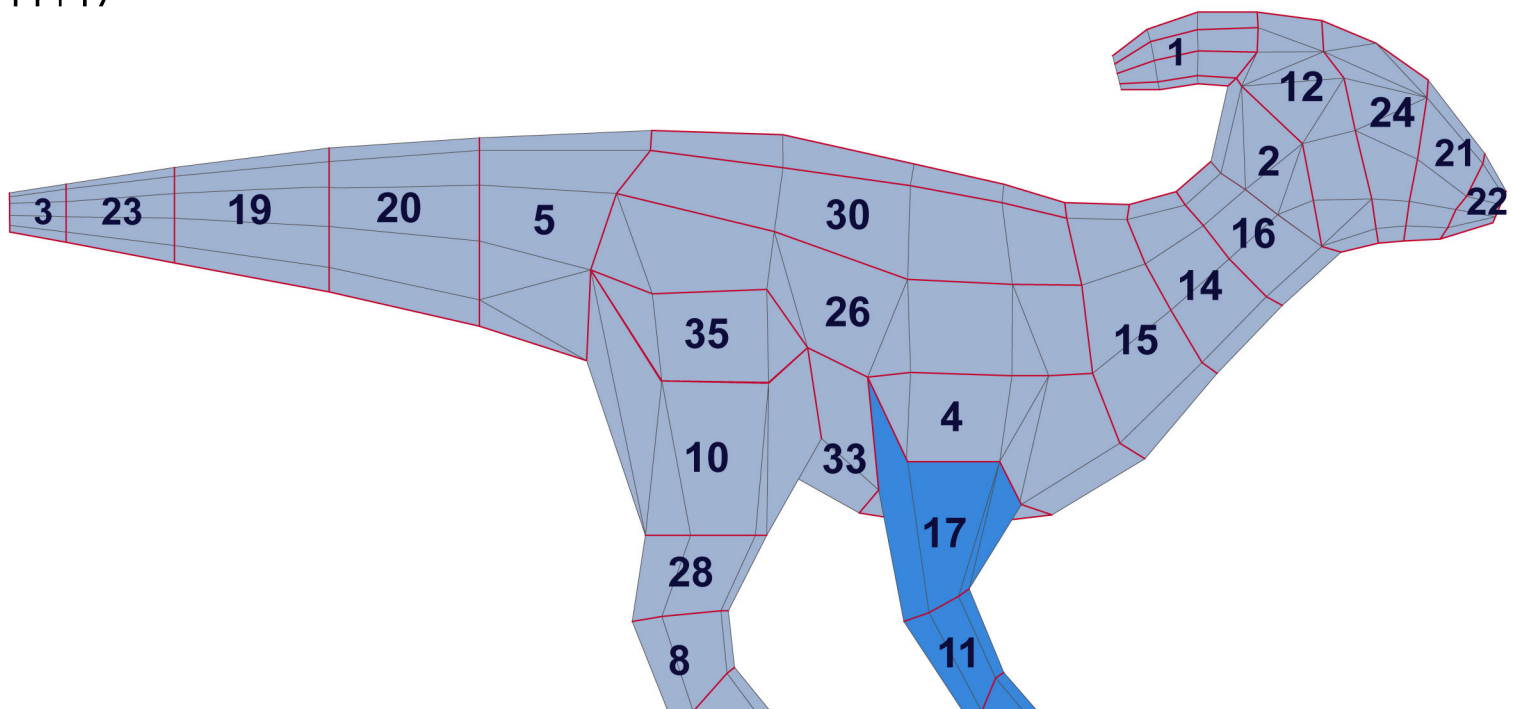

14

33

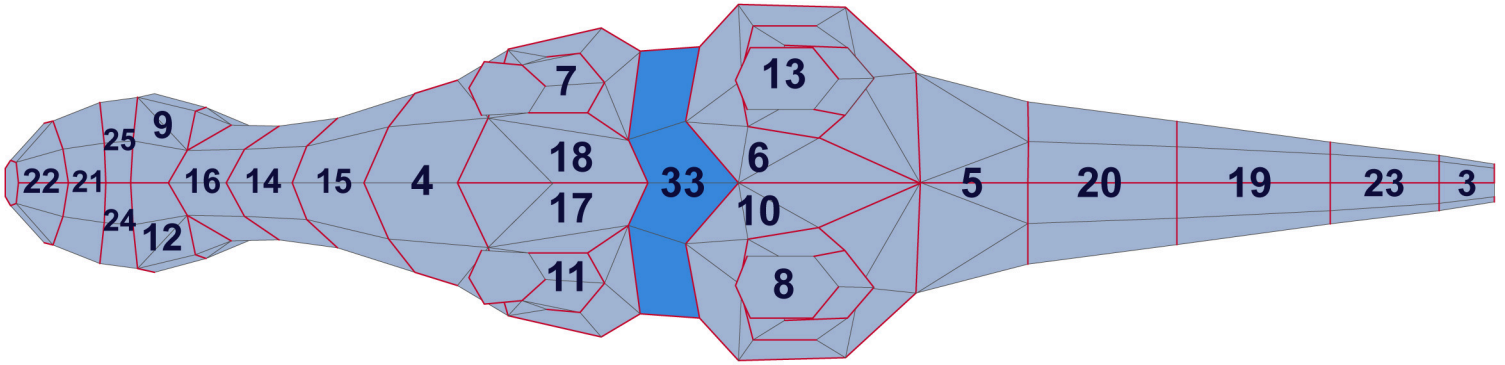

15

13+29
8+28

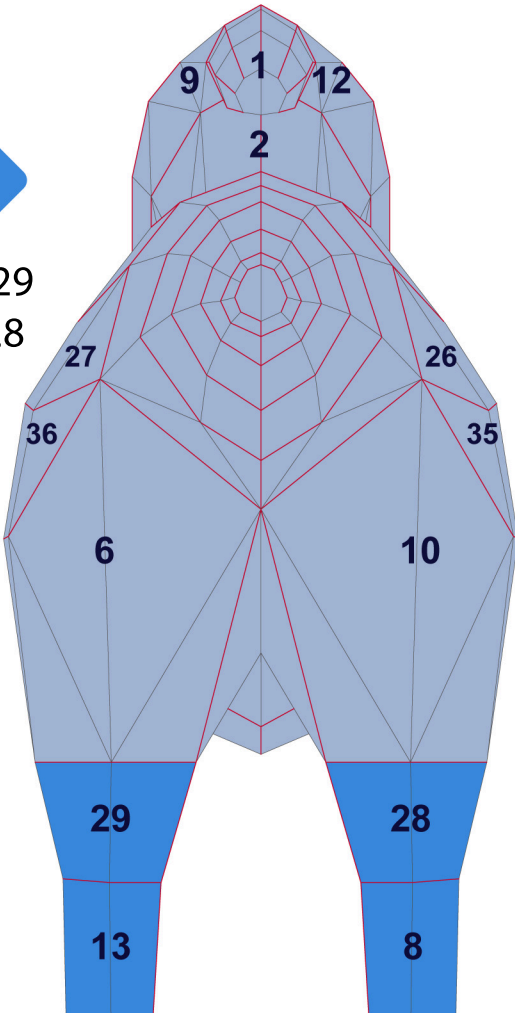

16

6+10

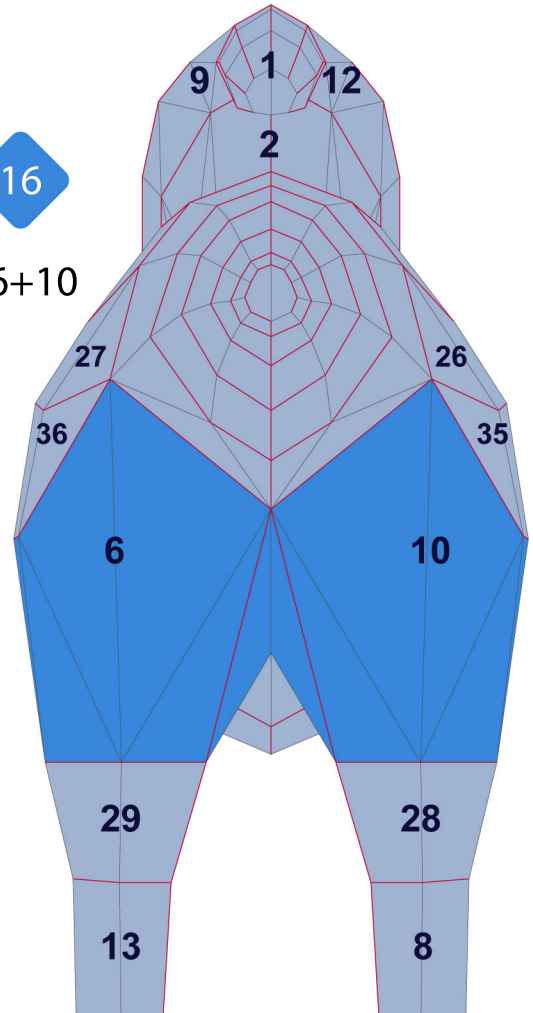

17

36

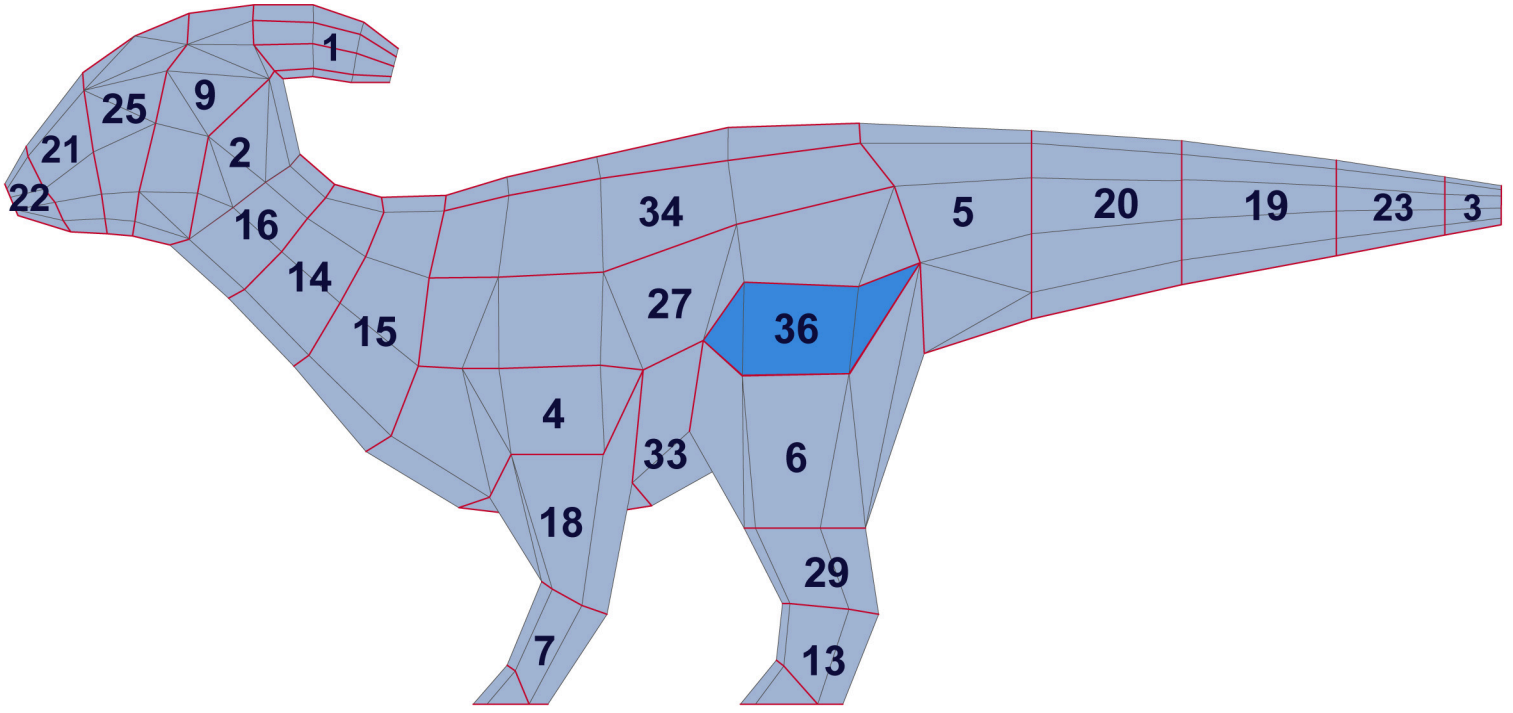

18

35

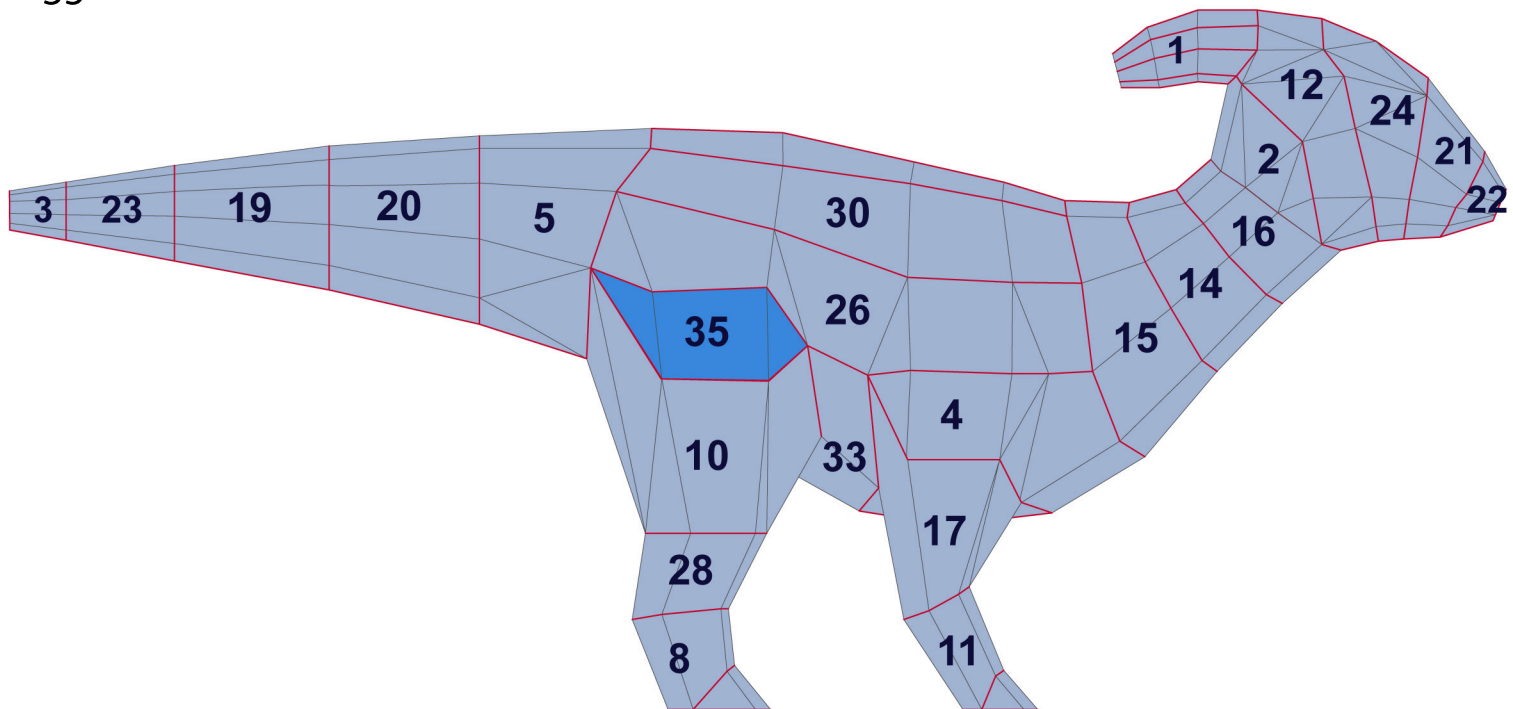

19

27

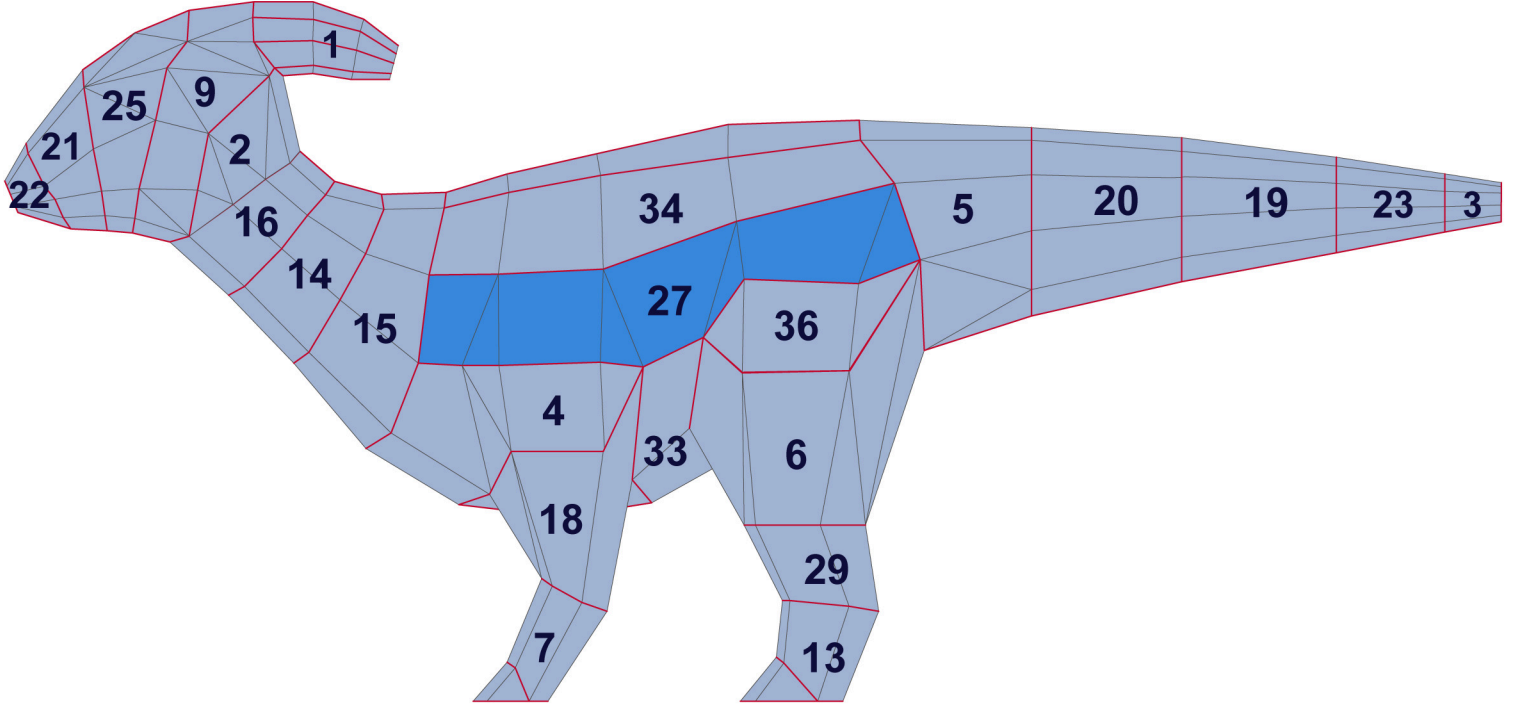

20

26

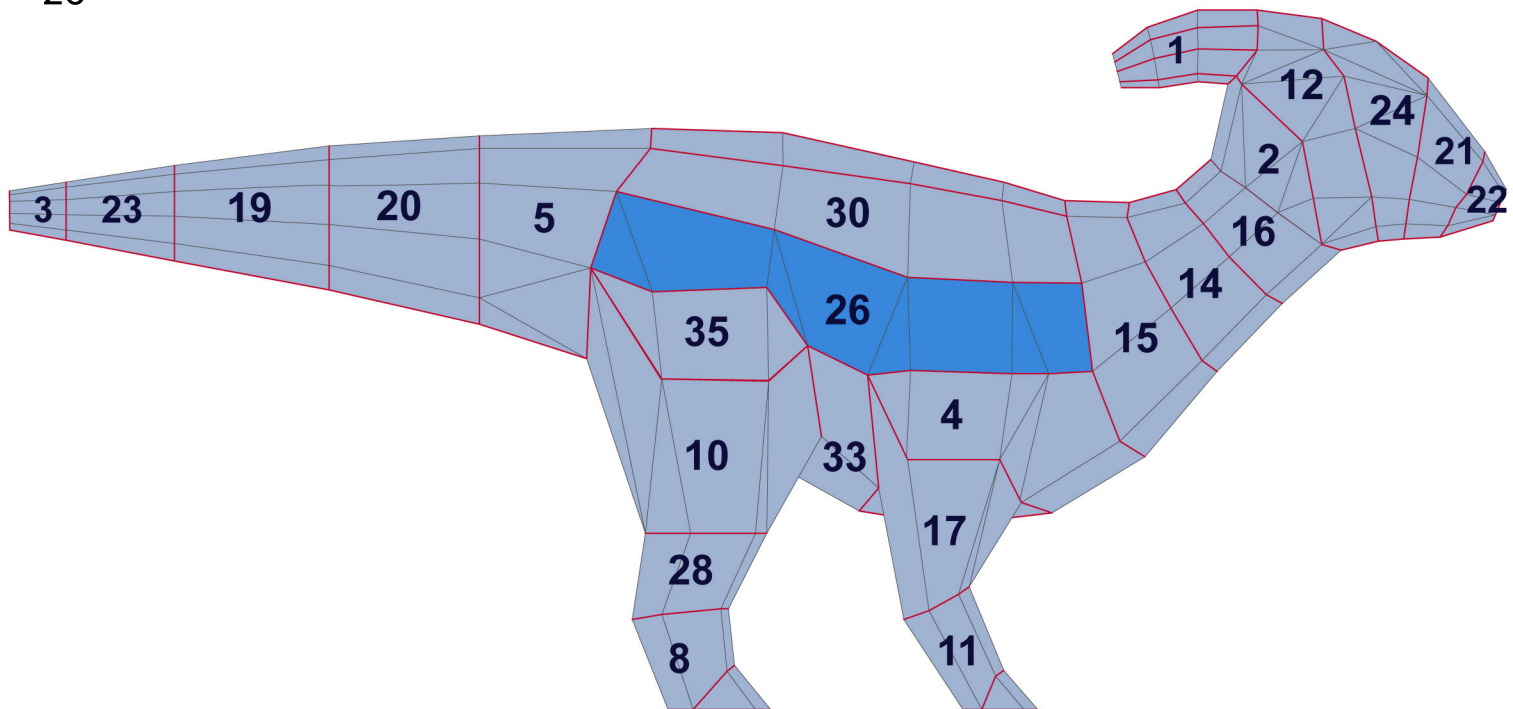

21

$$34+31+32+30$$

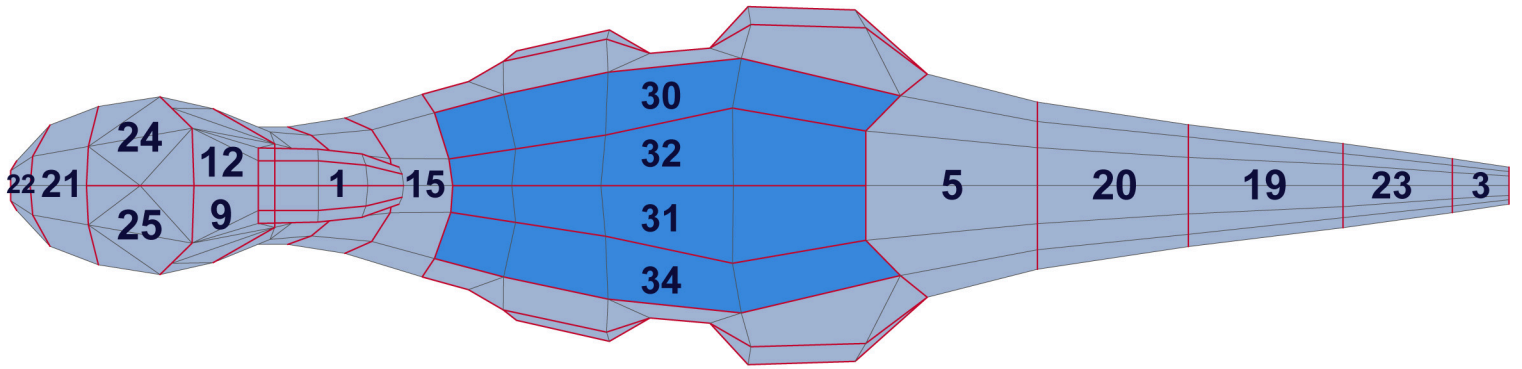

22

$$5+20+19+23+3$$

